

Sensori fotoelettrici con corpo cubico 50x50 mm – serie Q5

Cubic photoelectric sensors
50x50 mm – Q5 series



Caratteristiche principali Main features

- > Modelli in AC ed in DC
> AC and DC models
- > Corpo cubico compatto 50x50x18 mm
> Compact cubic housing 50x50x18 mm
- > Vasta gamma di modelli: riflessione diretta, polarizzati, a catarifrangente ed a barriera
> Wide range of models: diffuse reflection, polarized, retroreflective and through beam
- > Approvazioni: CE
> Approvals: CE

Descrizione del codice - Code structure

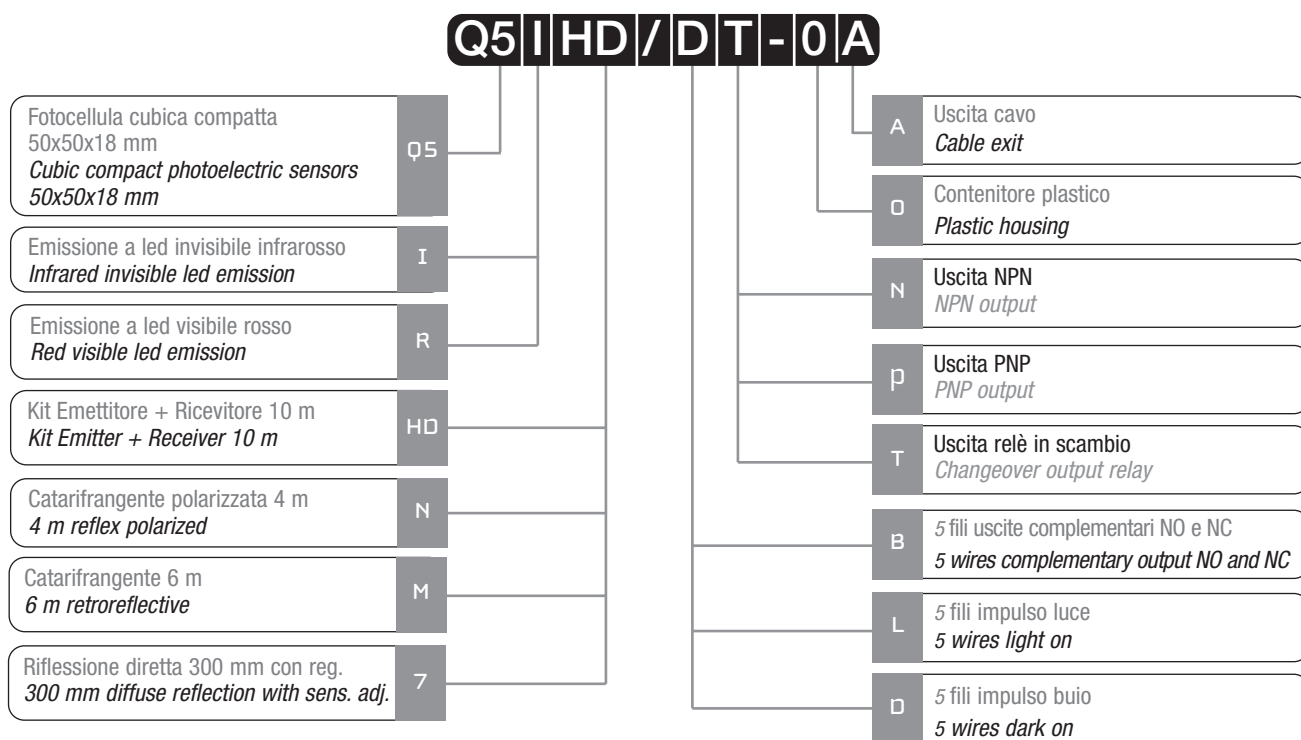

Modelli disponibili - Available models

Funzione / Function	Portata Distance	Regolaz. Adjust.	Relè LO+DO Relay LO+DO	Relè LO Relay LO	NPN LO+DO	PNP LO+DO
Barriera / Through-beam	10 m	NO	Q5IHD/DT-0A	-	Q5IHD/BN-0A	-
Polarizzata / Polarized	4 m	NO	Q5RN/DT-0A	-	Q5RN/BN-0A	Q5RN/BP-0A
Catarifrangente / Retroreflective	6 m	NO	Q5RM/DT-0A	-	Q5RM/BN-0A	-
Riflessione diretta / Diffuse reflection	300 m	Si / Yes	-	Q5I7/LT-0A	Q5I7/BN-0A	-

Specifiche - Specifications

	Barriera Through-beam	Polarizzata Polarized	Catarifrangente Retroreflective	Riflessione diretta Diffuse reflection
Modelli / Models	Q5IHD/**-0A	Q5RN/**-0A	Q5RM/**-0A	Q5I7/**-0A
Distanza di rilevazione nominale Nominal sensing distance	10 m	4 m	6 m	300 mm
Emissione / Emission	Infrarossa / Infrared (950 nm)	Rossa / Red (660 nm)	Rossa / Red (660 nm)	Infrarossa / Infrared (950 nm)
Corsa differenziale Differential travel	< 20%			
Ripetibilità / Repeat accuracy	5 %			
Tensione alimentazione Operating voltage	12 ... 240 Vdc ± 10%			
Ondulazione residua / Ripple	24 ... 240 Vac – 50/60 Hz ± 10%			
Potenza assorbita Power consumption	≤ 3 W	≤ 2 W		
Corrente di uscita / Load current	250 Vac, 3 A (cos φ=1) max. / 5 Vdc, 10 mA min.			
Uscita a relè / relay output	48 Vdc, 100 mA max			
Uscita statica / static output	48 Vdc, 100 mA max			
Corrente di perdita Leakage current	≤ 0,1 mA (solo modelli con uscita statica / only models with static outputs)			
Caduta di tensione in uscita Output voltage drop	≤ 2 V (solo modelli con uscita statica / only models with static outputs)			
Tipo uscita / Output type	Relè / Relay SPDT o / or NPN – LO/DO	Relè / Relay SPDT o / or PNP o / or NPN – LO/DO	Relè / Relay SPDT o / or NPN – LO/DO	
Tempo di risposta Response time	≤ 30 ms (uscita relè / relay output) ≤ 5 ms (uscita statica / static output)			
Ritardo alla disponibilità Time delay before availability	200 ms			
Protezione elettriche alimentazione Supply electrical protections	Inversione di polarità, sovratensioni impulsive (uscita statica) Polarity reversal, overvoltage (static output)			
Protezione elettriche uscita Output electrical protection	Corto circuito, non autoripristinante (uscita statica) Short circuit, without autoreset (static output)			
Regolazione di sensibilità Sensitivity adjustment	---			Trimmer
Temperatura operativa Operative Temperature range	-25 ... + 55°C (senza condensa / without freeze) Umidità relativa / Relative humidity: 45% ... 85%			
Temperatura di immagazzinamento Storage temperature	-30 ... + 70°C (senza condensa / without freeze) Umidità relativa / Relative humidity: 35% ... 95%			
Deriva termica Temperature drift	±15%			
Compatibilità elettromagnetica EMC	Conforme ai requisiti della Direttiva CE 2004/108/CE in accordo a EN 60947-5-2 Conforming to the EC Directive 2004/108/EC requirements according to EN 60947-5-2			
Interferenza alla luce esterna Interference by external light	3000 lux (lampada ad incandescenza / incandescent lamp) 10000 lux (luce solare / sunlight)			
Grado di protezione Protection degree	IP64 (IEC 60529)			
Indicatori LED/ LED indicators	Led Rosso: Stato dell'uscita / Red Led: Output state			
Materiale contenitore Housing material	ABS			
Materiale ottica / Optic material	PMMA			
Peso (appros.) / Weight (approx)	420 g (approx.)	250 g (approx.)		
Uscita / output	Cavo 2 m / 2 m cable			

Schemi elettrici delle connessioni - Electrical diagrams of the connections

Uscita complementare NPN - NO+NC
NPN - NO+NC complementary output

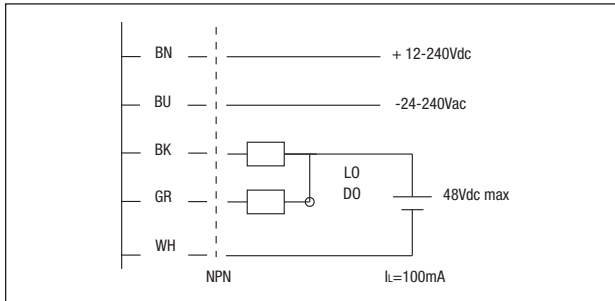

Uscita a relé
Relay output

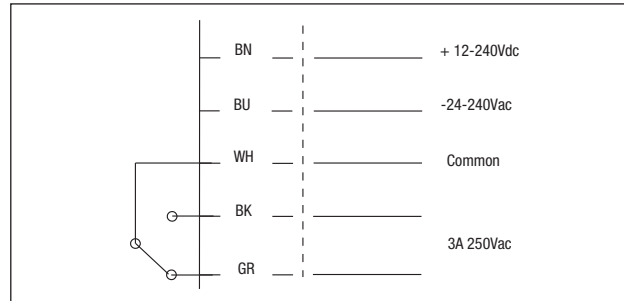

Uscita complementare PNP - NO+NC
PNP - NO+NC complementary output

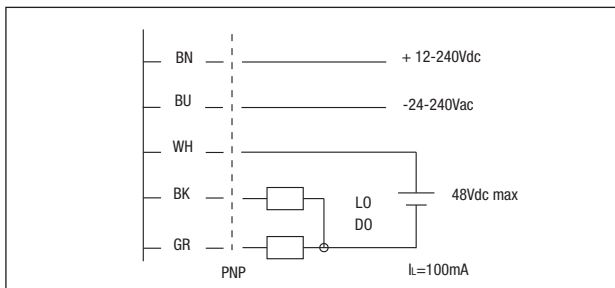

Emettitore
Emitter

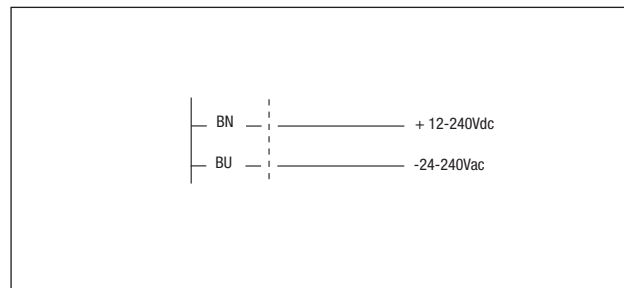

Legenda Key

BN → marrone/brown BU → blu/blue
BK → nero/black WH → bianco/white
GY → grigio/grey

Curva di risposta - Response diagram

Q5IHD/**-0A

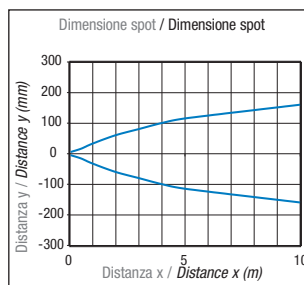
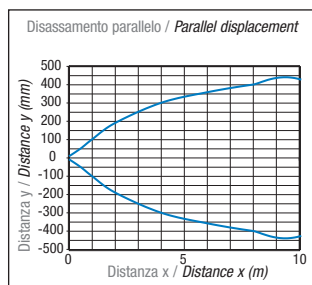
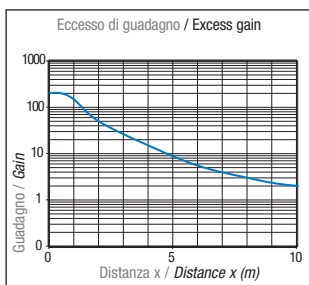

Q5RN/**-0A

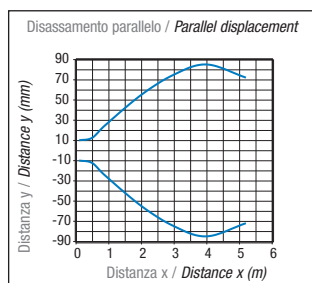
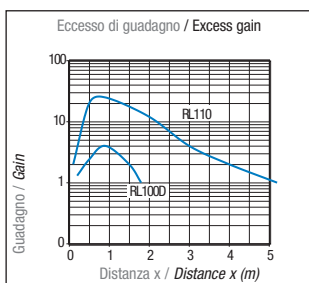

Q5RM/**-0A

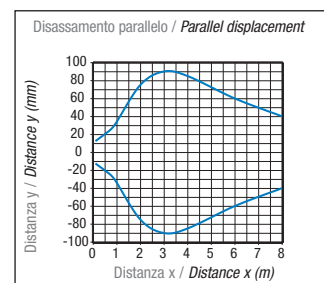
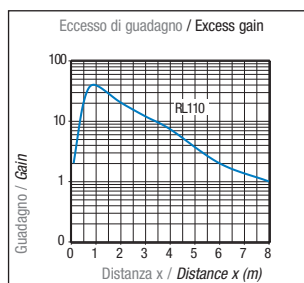

Q517/**-0A

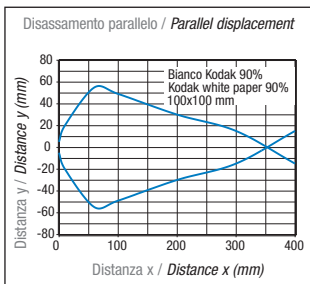
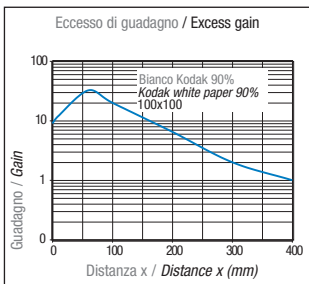

Dimensioni - Dimensions

Modelli a diffusione diretta e catarifrangente / Direct diffuse and retroreflective models

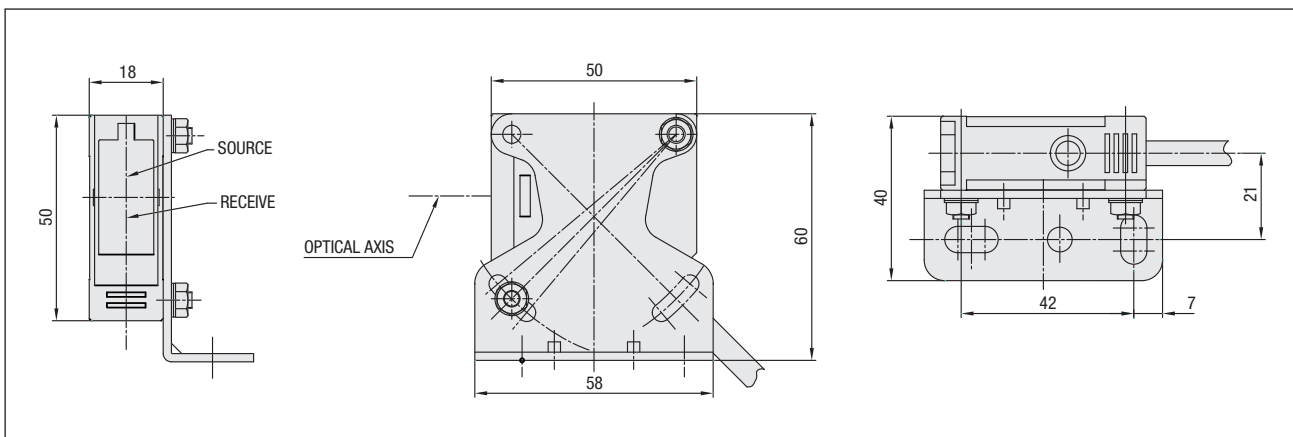

Modelli a barriera / Through beam models

