

Sensori fotoelettrici M18 per ambienti gravosi IP69K serie FF

M18 photoelectric sensors for harsh environments IP69K FF series



Caratteristiche principali

Main features

- > Corpo in acciaio inox AISI 316L (DIN 1.4404)
- > AISI 316L (DIN 1.4404) stainless steel housing
- > Indicatori LED: giallo (uscita), verde (funzione di teach-in)
- > LED status indicators: yellow (output), green (teach-in function)
- > Grado di protezione IP67 - IP68 - IP69K
- > IP67 - IP68 - IP69K protection degree
- > Totalmente protetti contro danneggiamenti di tipo elettrico
- > Complete protection against electrical damages

Disponibili, su richiesta, modelli ATEX, cat. 3
ATEX models, cat. 3, available on request

- > Modelli a diffusione diretta, polarizzati, barriera
- > Direct diffuse, polarized, through beam models
- > Funzione di teach-in innovativa attraverso il tubo della fotocellula
- > Innovative teach-in function through sensor's housing
- > Approvazioni: CE e cULus Listed
- > Approvals: CE and cULus Listed

Descrizione del codice - Code structure

FF R3/BP-1E

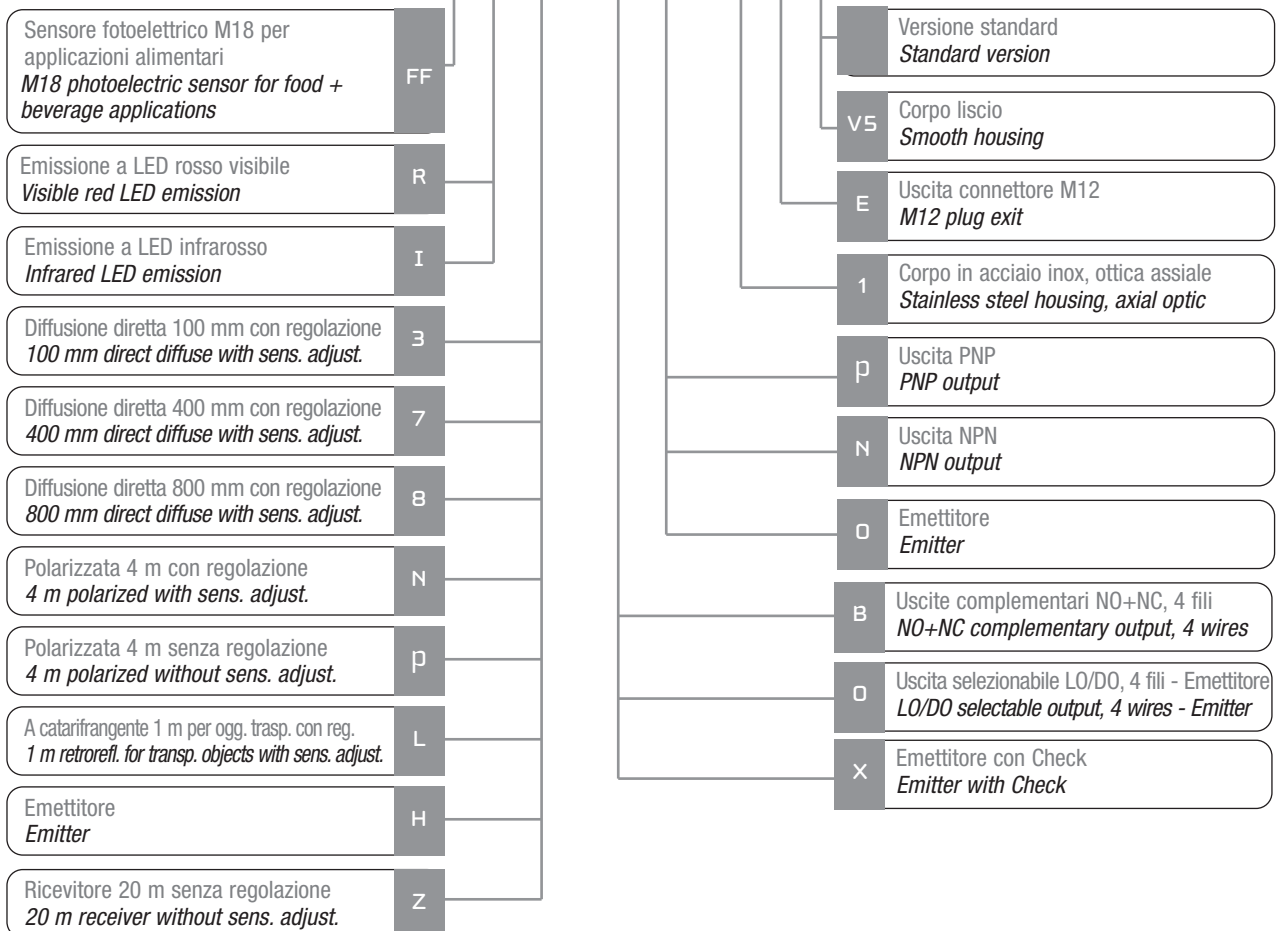

Modelli disponibili - Available models

Modelli Models	Corpo Housing	Regolazione Adjustment	Portata Distance	4 fili/Wires NPN LO/DO	4 fili/Wires PNP LO/DO	4 fili/Wires NPN NO+NC	4 fili/Wires PNP NO+NC
Diffusione diretta Direct diffuse	AISI 316L (DIN 1.4404)	Teach-in	100 mm	FFR3/ON-1E	FFR3/OP-1E	FFR3/BN-1E	FFR3/BP-1E
			400 mm	FFI7/ON-1E	FFI7/OP-1E	FFI7/BN-1E	FFI7/BP-1E
			800 mm	FFI8/ON-1E	FFI8/OP-1E	FFI8/BN-1E	FFI8/BP-1E
Polarizzata Polarized	AISI 316L (DIN 1.4404)	Teach-in	4 m	FFRN/ON-1E	FFRN/OP-1E	FFRN/BN-1E	FFRN/BP-1E
		No	4 m	FFRP/ON-1E	FFRP/OP-1E	FFRP/BN-1E	FFRP/BP-1E
Catarifrangente per trasparenti Retroreflective for transparent objects	AISI 316L (DIN 1.4404)	Teach-in	1 m	FFRL/ON-1E	FFRL/OP-1E	FFRL/BN-1E	FFRL/BP-1E
Ricevitore Receiver	AISI 316L (DIN 1.4404)	No	20 m	FFIZ/ON-1E	FFIZ/OP-1E	FFIZ/BN-1E	FFIZ/BP-1E
Emittitore con check Emitter with check	AISI 316L (DIN 1.4404)	No	20 m	FFIH/X0-1E			
Emittitore senza check Emitter without check	AISI 316L (DIN 1.4404)	No	20 m	FFIH/00-1E			

Specifiche (In accordo con IEC EN 60947-5-2) - Specifications (According to IEC EN 60947-5-2)

Modello / Model	Diffusione diretta Direct diffuse			Catarifrangente Retroreflective			Barriera Through beam	
	FFR3	FFI7	FFI8	FFRN	FFRP	FFRL	FFIZ	FFIH
Distanza di rilevamento nominale (Sn) Nominal sensing distance (Sn)	100 mm (1)	400 mm (2)	800 mm (3)	4 m (4)		1 m (5)	20 m	
Emissione / Emission	Rosso Red (660 nm)	Infrarosso Infrared (880 nm)		Rosso Red (660 nm)			-	Infrarosso Infrared(880 nm)
Corsa differenziale / Differential travel	≤ 10%							
Ripetibilità / Repeat accuracy	5%							
Tolleranza / Tolerance	+15/-5% Sn							
Tensione di alimentazione Operating voltage	10-30 Vdc							
Ondulazione residua / Ripple	≤ 10%							
Corrente assorbita No load supply current	max 35 mA (at Val=30V)						25 mA	40 mA
Corrente di uscita / Load current	100 mA							-
Corrente di perdita / Leakage current	≤ 10 µA @ Vmax							-
Caduta di tensione in uscita Output voltage drop	2 V _{max} . I _L =100mA							-
Tipo di uscita / Output type	NPN o / or PNP Uscita selezionabile / Selectable output LO/DO o / or Uscita complementare / Complementary output NO+NC							-
Frequenza di commutazione Switching frequency	500 Hz						250 Hz	-
Ritardo alla disponibilità Time delay before availability	200 ms							
Protezioni elettriche alimentazione Supply electrical protections	Inversioni di polarità, transienti Polarity reversal, transient							
Protezioni elettriche uscita Supply electrical output	Corto circuito (autoripristinante) Short circuit (autoreset)							-
Regolazione di sensibilità Sensitivity adjustment	Teach		NO		Teach		NO NO	
Limiti di temperatura operativa Temperature range	-25°C...+80°C (senza ghiaccio / without freeze)							
Deriva termica / Temperature drift	10% Sr							
Interferenza alla luce esterna Interference external light	5000 lux (Lampada incandescente / Incandescent lamp) 10000 lux (luce solare / sunlight)							
Grado di protezione / Protection degree	IP67; IP68 (1m , 7 giorni / days); IP69K (secondo / according to DIN 40050 part 9) ®							
Indicatori LED LED indicators	Verde / Green ON: funzione di teach disponibile / teach function available OFF: funzione di teach bloccata / teach function blocked Lampeggio veloce / Fast flashing: teach fine attivo / fine teach active Lampeggio lento / Slow flashing: teach in corso / teach in progress Giallo / Yellow Stato dell'uscita – Eccesso di guadagno / Output state - Excess gain (*) (0 modelli / models) Stato luce – Eccesso di guadagno / Light State / Excess gain (*) (B modelli / models)						Giallo Yellow: Stato uscita Output state (0 modelli models); Stato luce Light State (B modelli models)	Giallo Yellow: Alimentazione attiva Supply on
Materiale corpo / Housing material	Acciaio inox / Stainless steel AISI316L (DIN 1.4404)							
Uscita a connettore / Exit Plug	Grilamid							
Material ottica / Optic material	Ottica piana / Flat plane Plastico / Plastic, FDA certificata / certified							
Coppia di serraggio / Tightening torque	107 Nm							
Approvazioni / Approvals	CE, cULus, IP68, IP69K, ECOLAB, Johnson Diversey							
Peso (appross.) / Weight (approx)	120gr							

(1) Con ostacolo bianco Kodak 90% 100x100 mm / White target Kodak 90% reflection 100x100 mm

(2) Con ostacolo bianco Kodak 90% 200x200 mm / White target Kodak 90% reflection 200x200 mm

(3) Con ostacolo bianco Kodak 90% 400x400 mm / White target Kodak 90% reflection 400x400 mm

(4) Con riflettore RL110 / With RL110 reflector

(5) Con riflettore RL113G o RL116 / With RL113G or RL116 reflector

(6) Protezione garantita solo con il cavo a connettore correttamente montato / Protection guaranteed only with plug cable well mounted

(*) LED giallo ON fisso: eccesso di guadagno ≤ 2 / Yellow LED Fixed On: Excess Gain ≤ 2

LED giallo lampeggiante: eccesso di guadagno <2 / Yellow LED flashing: Excess Gain <2

Schemi elettrici delle connessioni - Electrical diagrams of the connections

> Uscita selezionabile LO/DO - LO/DO selectable output

Uscita NPN / NPN output

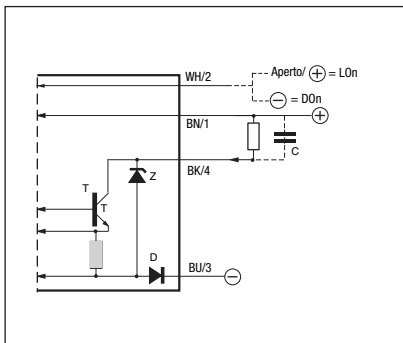

Uscita PNP / PNP output

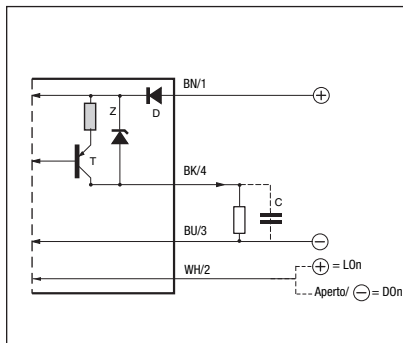

Legenda Key

BN → marrone/brown
BK → nero/black
BU → blu/blue
WH → bianco/white

> Uscita complementare NO+NC
NO+NC complementary output

Uscita NPN / NPN output

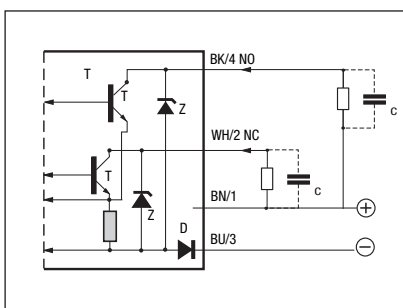

Uscita PNP / PNP output

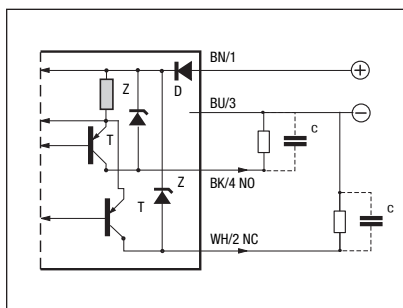

> Emettitore con check
Emitter with check

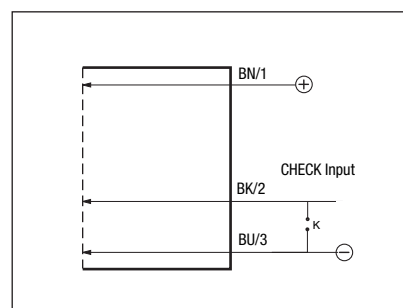

Connettore - Plug

M12 Emittitore senza check
Emitter without check

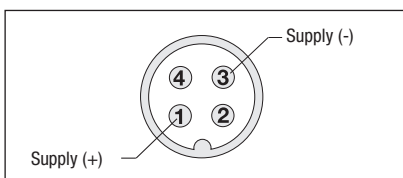

M12 Emittitore con check
Emitter with check

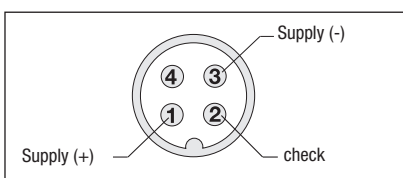

M12 Tasteggio diretto / Diffuse reflection
Polarizzata / Polarized
Ricevitore / Receiver

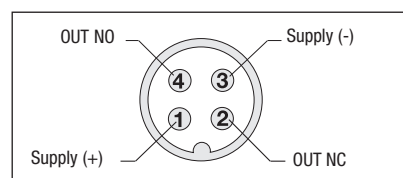

M12 Tasteggio diretto / Diffuse reflection
Polarizzata / Polarized
Ricevitore / Receiver

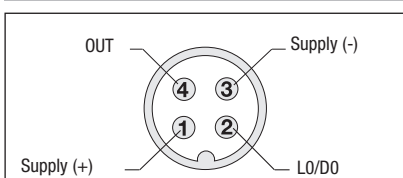

Curva di risposta - Response diagram

FFR3/**-1E

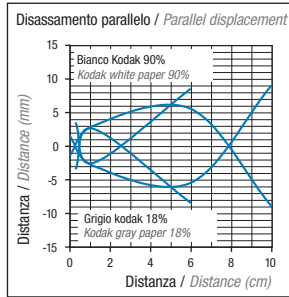
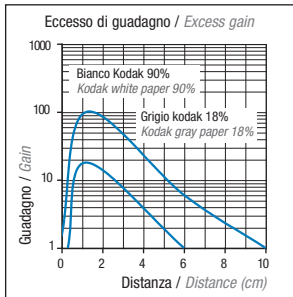

FFI7/**-1E

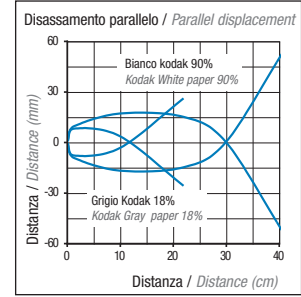
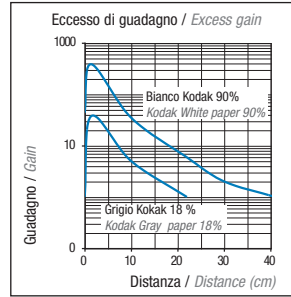

FFI8/**-1E

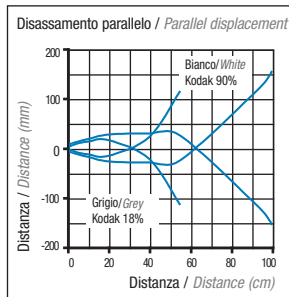
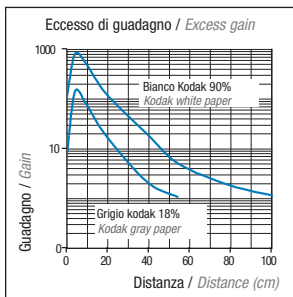

FFRN/**-1E - FFRP/**-1E

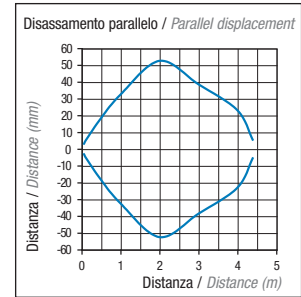
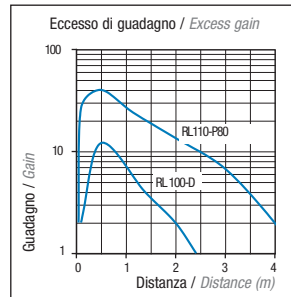

FFRL/**-1E

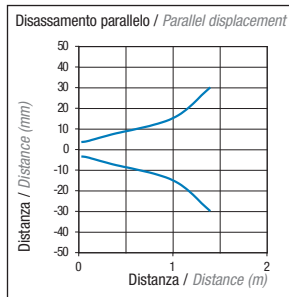
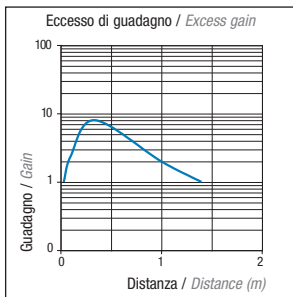

FFIH/**-1E + FFIZ/**-1E

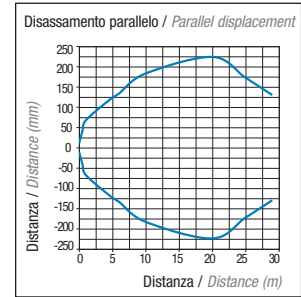
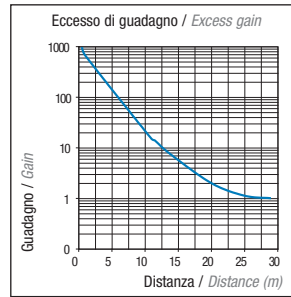

Dimensioni - Dimensions

